

Heater: 8kW with rocks
4-6 sauna bathers,
doors hinged left or right,
benches made of abachi,
wall paneling options:
Aspen or Cedar.

DETAILS

A = min. 4" (2.2 - 8kW)
min. 8" (10.7 - 16kW)

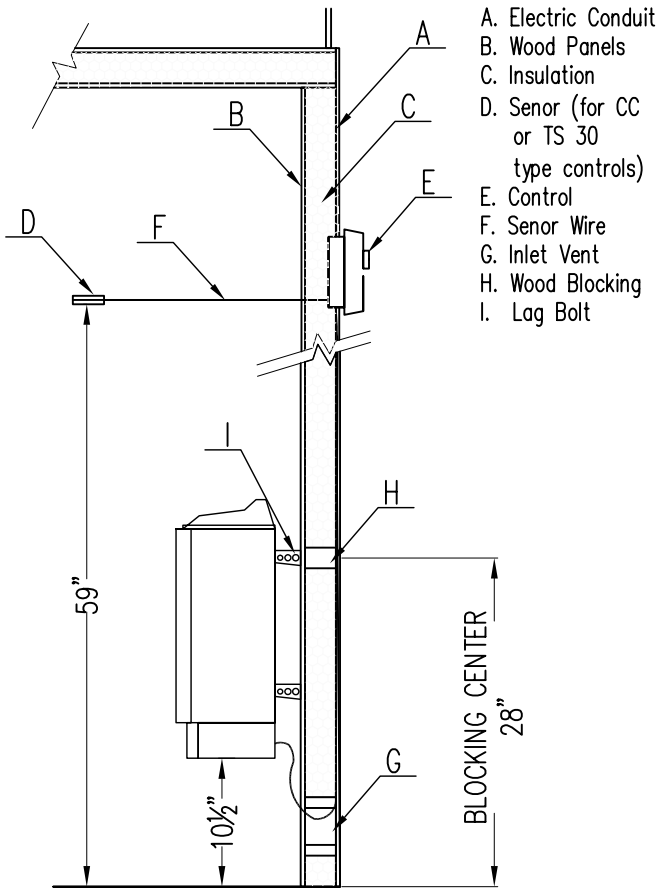

- A. Electric Conduit
- B. Wood Panels
- C. Insulation
- D. Sensor (for CC or TS 30 type controls)
- E. Control
- F. Sensor Wire
- G. Inlet Vent
- H. Wood Blocking
- I. Lag Bolt

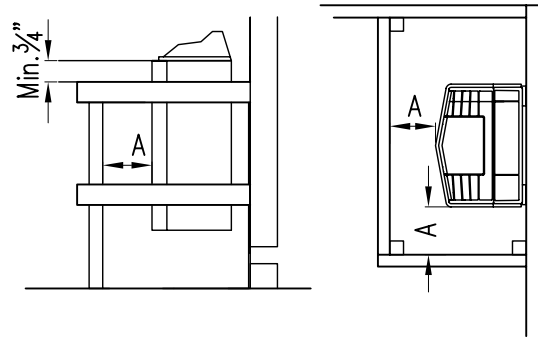

Minimum Distances for Heater Guard

NOTE: If using sport, supersport or combi heater disregard D, E & F

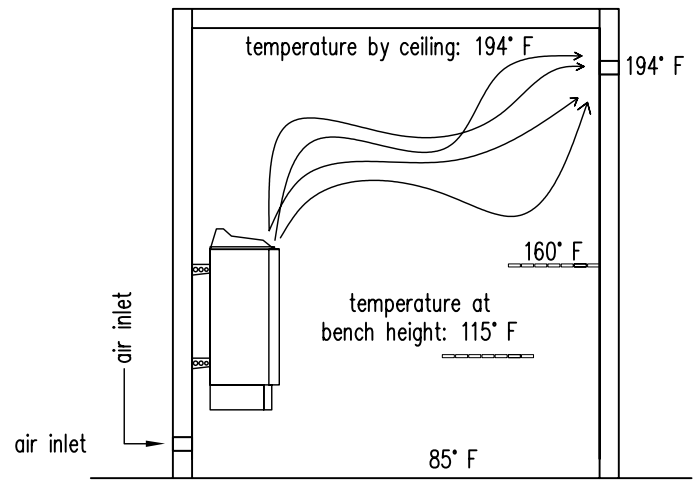

Outlet vent through wall. The outlet is placed high up, close to the ceiling.

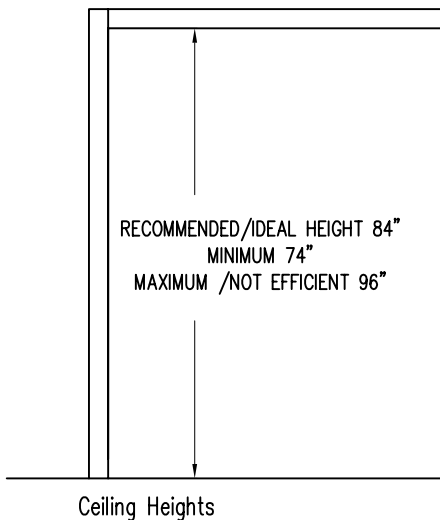

Ceiling Heights

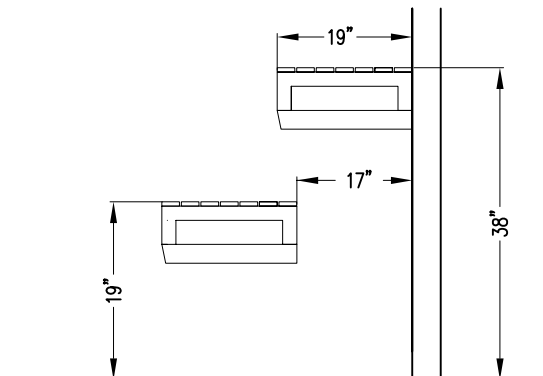

Bench Heights