

# HARVIA

## HARVIA VIRTA 8 KW FLOOR-STANDING SAUNA HEATER CONTROL PANEL VIRTA-80-240



### FEATURES

The Harvia Virta heater's strong structure and exceptional ease of maintenance make it excellently suitable for those who use the sauna often and like to enjoy the steam for long periods of time. All connections to the Virta heater are made through the maintenance hatch on the front. There is plenty of room around the connections. The heating elements are separated from the stones, which results in a long heating element life span. If you need to replace a heating element, it is a quick and easy task, as you can just pull out the entire heating element module.

### SPECIFICATIONS

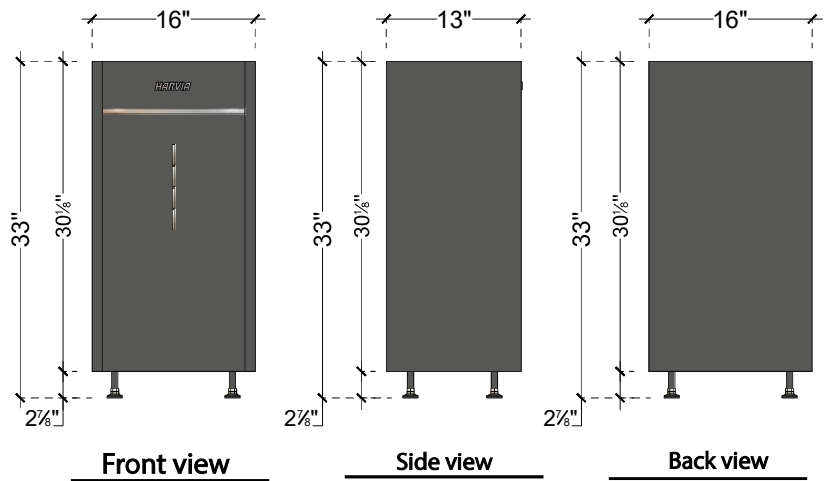

### CODES/STANDARDS



Intertek  
3159549

ETL LISTED  
CONFORMS TO  
UL STD 875  
CERTIFIED TO  
CAN/CSA STD  
E60335-2-53-05

**HARVIA® MADE IN FINLAND**

**Limited Warranty**

3 year residential  
(use limited)  
1 year commercial  
(use limited)



### AVAILABLE COLOR

Color	Description
■	Black

### ACCESSORIES

- Bucket with ladle.
- Sauna fragrances.
- Rocks. (120 Lb.)
- Heater guard.
- Control panel Xenio.
- Safety switch.
- Control unit.

Product weight: 50.7 Lb.

### CONTROL PANEL XENIO AND POWER UNIT

The control panel and power unit must be installed in a dry place, away from spa, pool, or shower, and not outdoors. A receptacle should not be installed inside the sauna room.

### INSTALLATION REQUIREMENTS

- Sauna heater.
- Control panel Xenio.
- Sensor.
- Power unit
- Venting is required for the sauna to operate properly. (Low vent in under sauna heater and a high vent out on opposite wall.)

# HARVIA

## HARVIA VIRTA 8 KW FLOOR-STANDING SAUNA HEATER CONTROL PANEL VIRTA-80-240

### SPARE PARTS

- Heating element 2650W/240V
- Adjusting leg M10x60
- Hi-limit
- Temperature sensor

### VOLTAGE AND SAUNA VOLUME

Voltage	Breaker size AMPS		Wire size AWG		Sauna volume min. cu. ft.	Sauna volume max. cu. ft.	Control unit	
	1-Group connection	2-Group connection	1-Group connection	2-Group connection			1-Group connection	2-Group connection
240 V 1-PH	40	30	8	10	177	431	CX45-U1-U3	CX45-U1-U3

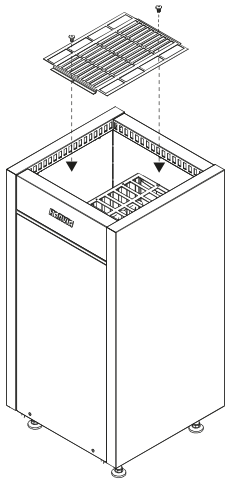

Before operating the heater, fill the heater with rocks and install the safety grid.

