

EOS MYTHOS S35 7.5 KW FLOOR-STANDING SAUNA HEATER EOS-MYT-E75-240

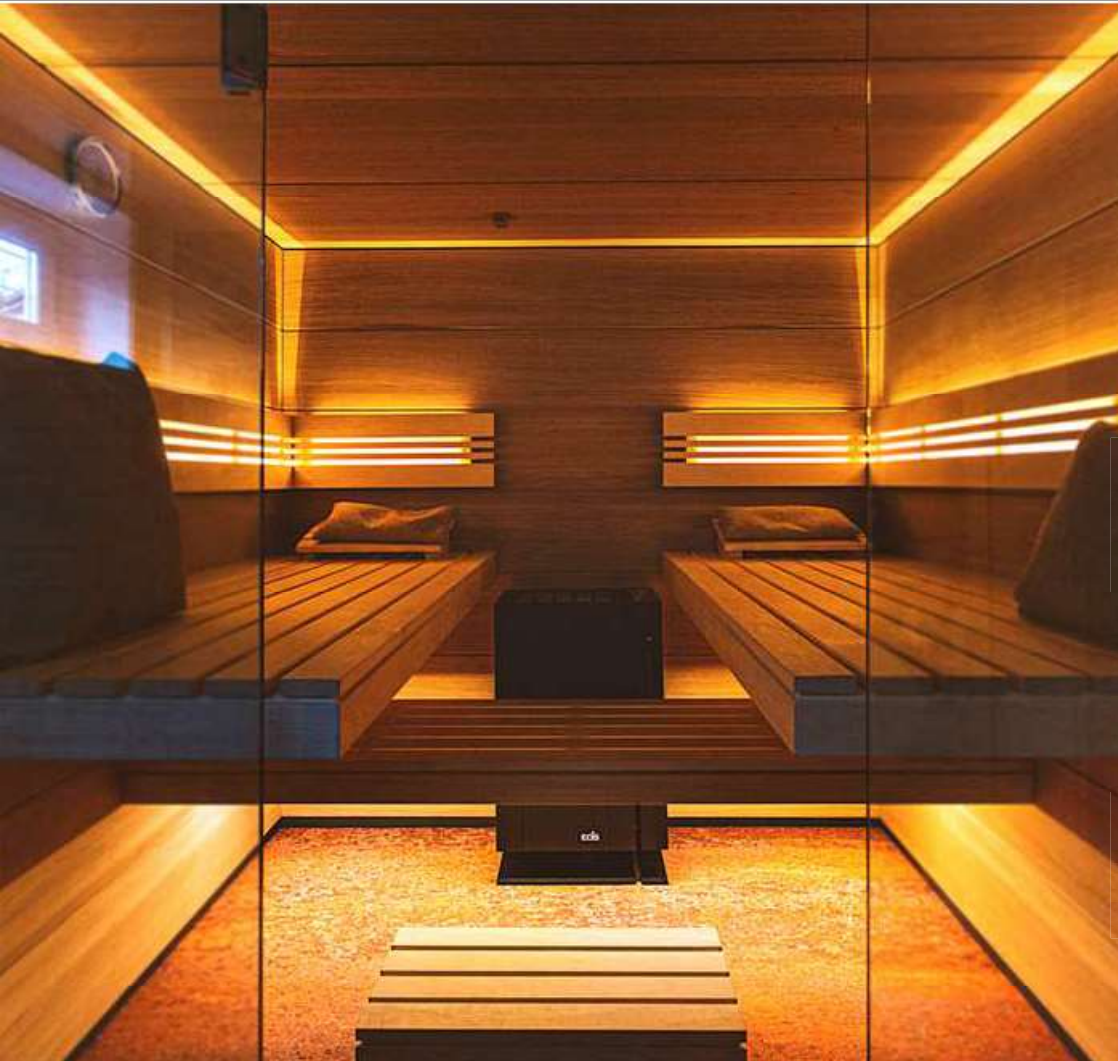

CODES / STANDARDS



Intertek
5023683



CONFORMS TO
UL STD 875
CERTIFIED TO
CAN/CSA STD
E60335-1/4E
E60335-2-53

MADE 
IN  EOS®
GERMANY 

Limited Warranty

2 year residential (use limited)

AVAILABLE COLORS

 White
 Black

ACCESSORIES

- Bucket with ladle.
- Sauna fragrances.
- Rocks. (77 Lb.)
- Mounting brackets for safety guard rail

FEATURES

Exclusive award-winning sauna heater for the dry Finnish sauna in distinctive cubistic design with the unique pillar-like foot. Cubius stones add the crowning touch to the outstanding design of this state-of-the-art model.

- Choice of different finishes: anthracite, brushed steel, matte black or white.
- Durable, long-lasting construction, all made of stainless steel.
- Uniform appearance on all sides, great for installation in front of glass panels.
- Slim, space-saving construction – only 1.2 ft depth.
- Modern cubic stone display.

TECHNICAL SPECIFICATION

Voltage	Breaker size AMPS	Wire size AWG	Sauna volume min. cu. ft.	Sauna volume max. cu. ft.	Weight
208 V 3Ph AC 60 Hz	50	12	280	420	74 Lb.
240 V 2Ph AC 60 Hz	40	10	280	420	74 Lb.

INTERCHANGABLE ROCKS

Cubius stones optionally available with extra height or as Cubius Loop. Some items can be sold separately.

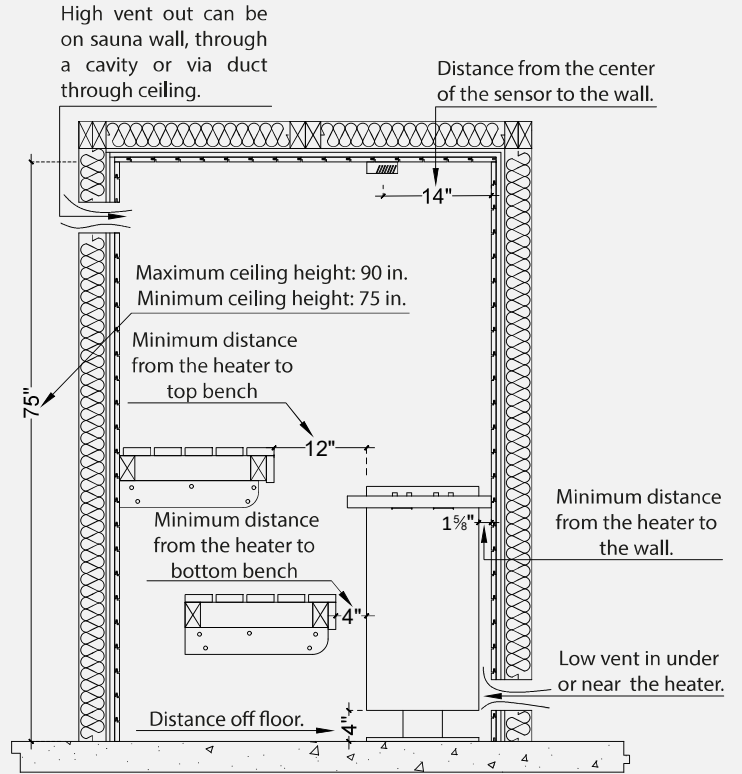
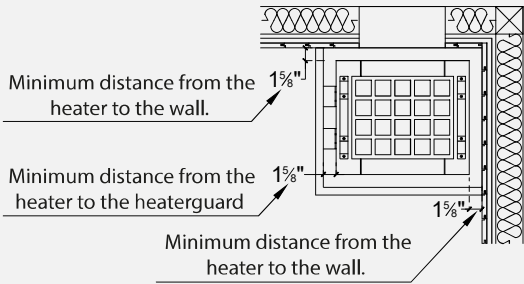

SPECIFICATIONS

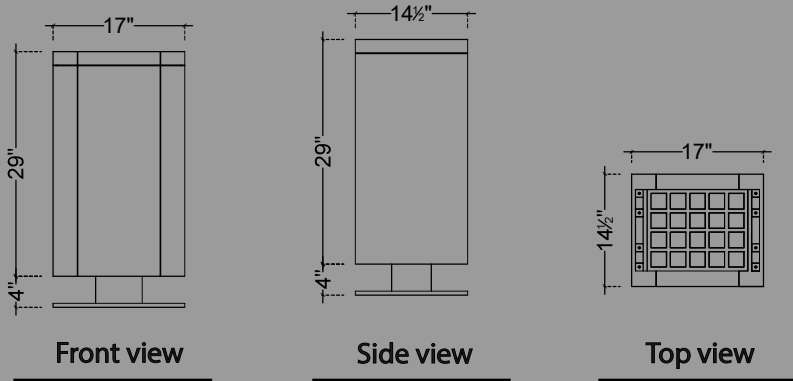

SENSOR POSITION

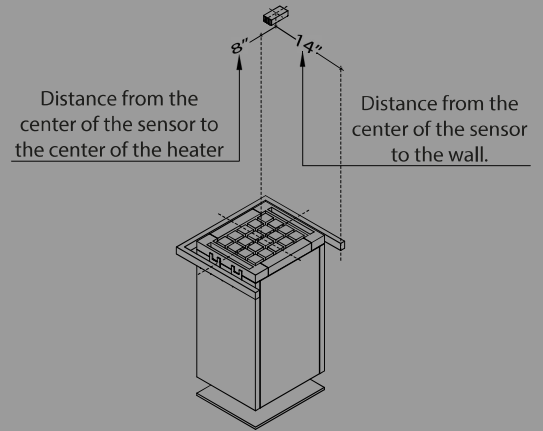

CONTROL PANEL EOS EMOTEC AND POWER SUPPLY

The control panel and power supply must be installed in a dry place, away from spa, pool, or shower, and not outdoors. A receptacle should not be installed inside the sauna room.

INSTALLATION REQUIREMENTS

- Sauna heater
- Control panel Eos Emotec
- Sensor
- Power supply for control unit

WIRING DIAGRAM

